

LTECH

# Super Panel

Manual

[www.ltech-led.com](http://www.ltech-led.com)

 Bluetooth®   RoHS

# Product Introduction

Super Panel is a central control panel that integrates all of your connected devices to control the entire smart home. Based on 5G speed with cloud computing, it has the powerful intelligent gateway function with Bluetooth 5.0 SIG Mesh technology and is compatible with Wi-Fi, Bluetooth 5.0 SIG Mesh and Ethernet.

Support button, touch, and mobile App control. Multiple scenes preset for any occasion can be quickly turned on or off merely through slight taps on the buttons.

Easily control your lighting, air conditioning, infrared home appliances, curtains and other items to build a complete smart home system.

Compatible with 86 type and European style standard junction boxes, no need to modify the wiring that can easily replace traditional switches.

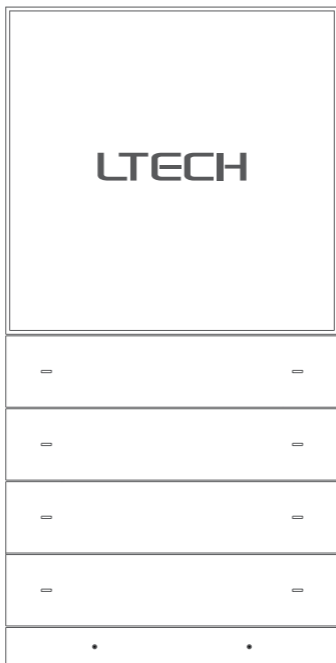

# Technical Specs

Product model: SP-GW-BLE

Input voltage: 100-240Vac

Wireless network: Wi-Fi, Bluetooth 5.0 SIG Mesh

Wired network: Ethernet

Display: 4.0-inch full lamination, 720×720 resolution

Touchpad: Capacitive multi-touch screen, anti-fingerprint coating

Proximity sensor: Close-range sensing within 15cm, automatic wakeup

Light sensor: Adjust the screen brightness automatically when lighting changes

Working environment: Temperature -15°C~50°C, Humidity≤85%RH

Body materials: Aviation aluminum, CNC machining techniques,  
PC + fiberglass, V0 fireproofing grade

Dimensions (L×W×H): 172×86×38mm

Junction boxes: 86 type, European style

## Package Contents

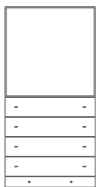

Super Panel×1

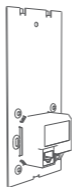

Base plate×1



Manual×1



KM4 screw×2



KA4 screw×2



PWA2 screw×2



KM2 screw×2



Expansion bolt×2

# Application Diagram

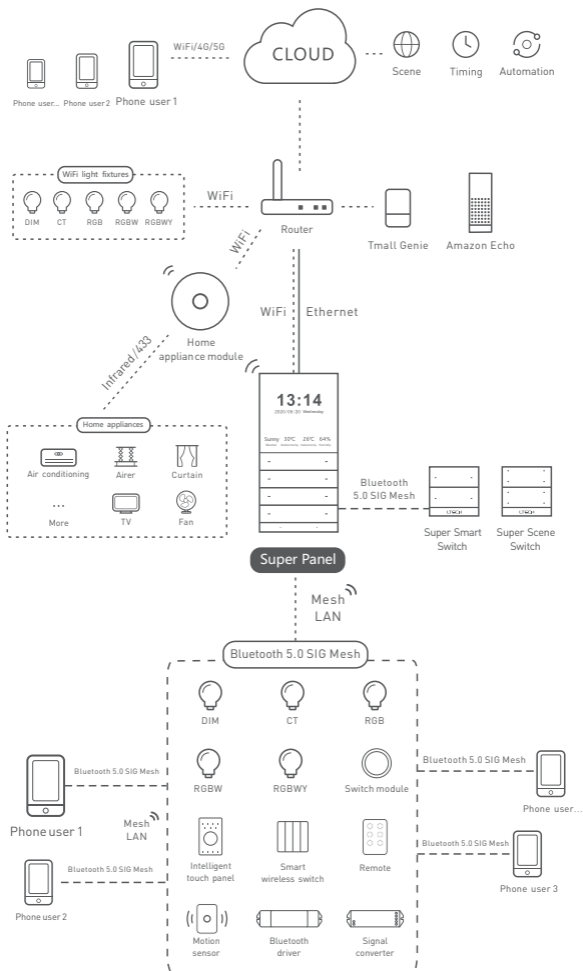

# Recommended Applications

## 1.App control,gain fast control of lamps

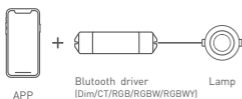

## 2. Both the remote and wireless switch can control lamps (With reliable and stable signals)

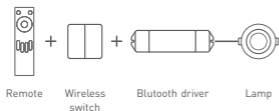

## 3.Wireless+wired control (Enriching different lighting applications)

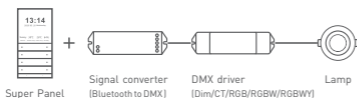

## 4. Super Panel supports both LAN+remote lighting control via 3G/4G/5G/Wi-Fi

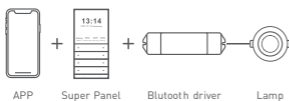

## 5. The Super Panel and home appliance module control lamps, air conditioning, curtains and other items (Customize cloud scenes and automatic applications)



## 6. The Super Panel,remote and wireless switch can simultaneously control lamps

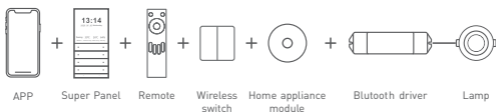

## 7. More applications of intelligent control are waiting for you to set up.

# Product Images

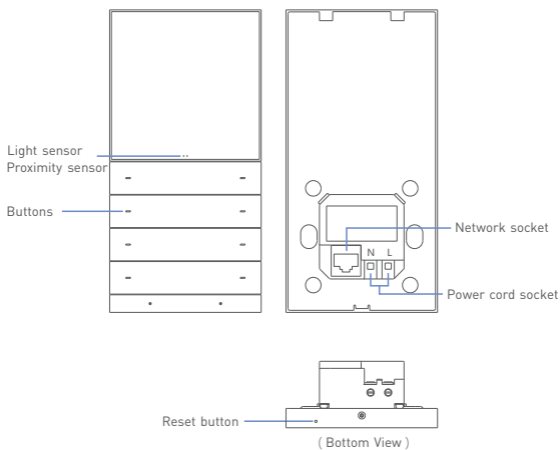

\* Reset button: Long press it for 16s until the screen turns on and displays the LTECH LOGO.

## Product Size Unit: mm

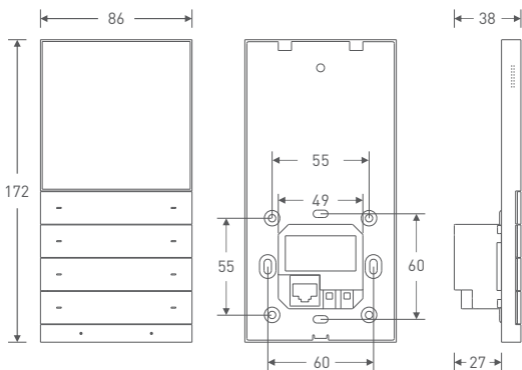

# How to Install A Super Panel

## 1. Trim the power cord

Turn off the circuit breaker and remove any concrete or corrosion that are inside the wall box. Trim the power cord in the wall box to 10cm in length approximately.

## 2. Fix the bottom of base plate

Attach the null line to N socket and live line to L socket, as shown in the diagram below. If necessary, insert a network cable into the network socket. Fix the bottom of base plate to the wall box and tighten the screws to secure it to the box.

Note: Make sure the base plate is stable and won't appear crooked.

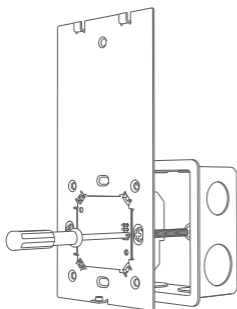
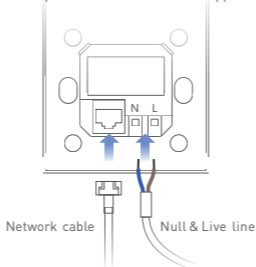

Install the 86 type junction box with KM4 screws

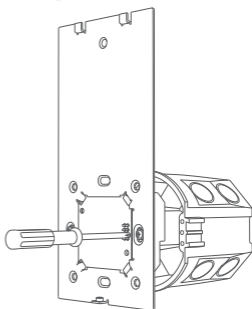

Install the European standard junction box with PWA2 screws

## Attentions

- The installation location should avoid being close to large-area metal objects against signal interference.
- Please use in a cool and dry environment.
- Please keep away from heat.
- Please do not open, change or repair, otherwise the warranty is not allowed.

### 3. Adjust the base plate

Insert the expansion bolt into the upper side of base plate, and place the KA4 screw into the bolt. Secure the KA4 screw to fit the base plate to the wall with a screwdriver. Otherwise, improper installation may cause damage to the product.

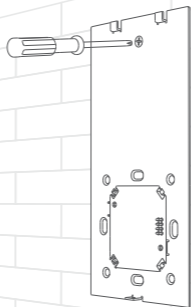

### 4. Put the Super Panel cover in place

Slant the bottom of Super Panel cover and put it in place, as shown below. Then secure the Super Panel cover to the base plate from the bottom with a KM2 screw.

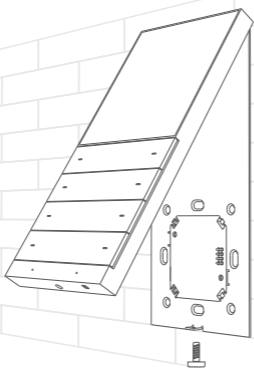

KM2 screw



# Instructions to Use SuperPanel

## 1. Swipe gesture control

- ① After Super Panel adding devices and scenes, the system will automatically generate different types of pages. You'll be able to swipe left and right to switch to any device page.
- ② Swipe down from the top of screen to access the control center; swipe up to close it.
- ③ Swipe up from the bottom of screen to access the button usage guidelines; swipe down to close it.

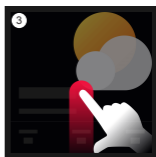
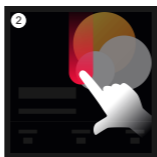

## 2. Physical buttons

There are eight physical buttons on the panel. The App allows you to bind a device action or scene to each button. For more details, please refer to P12. You'll be able to swipe up from the bottom of screen to go to the button usage guidelines and view the functionality of each button; swiping down lets it close.

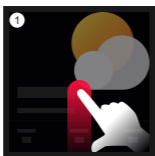

# App Operating Instructions

## 1. Register an account

- 1.1 Scan the QR code below with your mobile phone and follow the prompts to complete the app installation.



Scan and download the App

1.2 Open the App and log in or register an account.

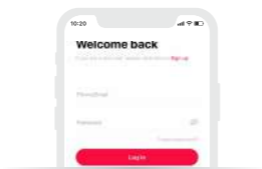

## 2. Configure the Super Panel

Power on the Super Panel and wait for a while to start it. Follow the page guidelines of panel to connect the Wi-Fi. Once connected successfully, a QR code for the device will be displayed on the interface and you'll be able to complete the configuration.

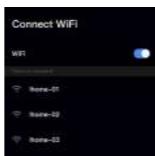
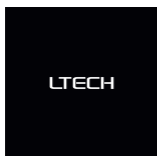

## 3. Bind your account

Open the APP and create a home if you are a new user. Click "+" icon in the upper right corner and access the "Add Device" list. Pick "Intelligent Gateway-Super Panel" from the "Add Device" list and follow the prompts to scan the QR code displayed on the Super Panel screen, then complete your account binding.



## 4. How to control lights, infrared appliances and other items with Super Panel

Please refer to manuals of related products. Follow the prompts to add the devices you want and access the Super Panel interface. Click "Device" and go to "Displayed Devices" interface. Click the icon in the upper right corner, pick the devices you want to control with the panel and save them. If you want to control bluetooth devices, please connect the Super Panel to bluetooth network before you start to bind home devices to the panel. Go to the Super Panel interface and click "Bluetooth Configuration". Then follow the prompts to configure the Super Panel to bluetooth network.

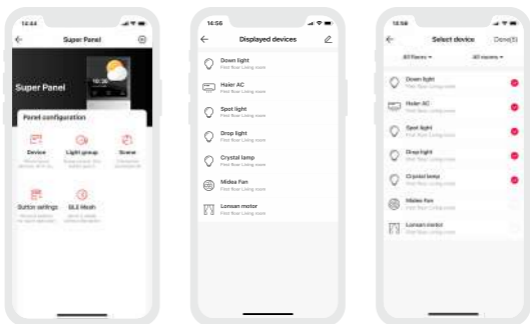

## 5. How to control light groups with Super Panel

Please refer to manuals of related products. Follow the prompts to add the devices you want and group the same type of light together. Go to the Super Panel interface and click "Light Group" to access "Displayed Light Groups" interface. Click the icon in the upper right corner and pick the groups you want to control with the panel.

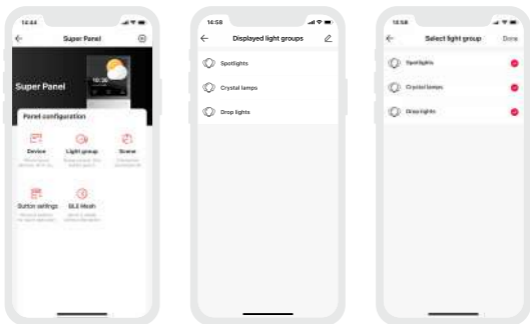

## 6. How to control cloud scenes with Super Panel

**Create scenes:** Get back to the homepage of the App. Switch to “Intelligence” menu and click “+” icon to add scenes. Follow prompts to modify names and icons for scenes, and click “Add Action” to set up the action and delay time you want. **Displayed scenes:** Go to the Super Panel interface and click “Scene” to access “Displayed Scenes” interface.

Click the icon in the upper right corner to add the scenes you want to control with the Super Panel.

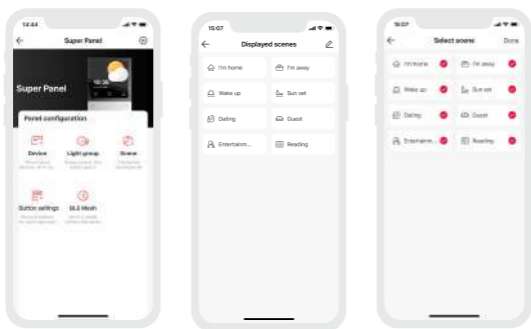

## 7. Physical button settings

Go to the Super Panel interface and click “Button settings” to set up. Click the button you want and follow the prompts to set up the device action or scene performed by this button.

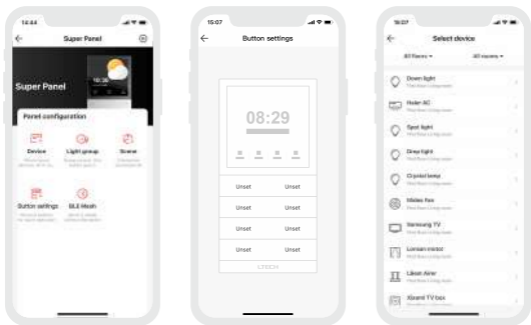

## FAQs

### 1. What should I do if I fail to configure the device to the Internet?

- 1.1 Please make sure the device is powered on normally.
- 1.2 Please make sure the device hasn't been added by any other account.  
If it did, please delete it on the APP and add it again.
- 1.3 Please keep your mobile phone, device and router as close as possible.
- 1.4 Please make sure your router account and password are correct, and the router works with network available.

### 2. How to change user accounts?

Super Panel has one standard user account only. The Super Panel that has been added needs to be deleted by the original owner before your login.

\* This manual is subject to changes without further notice. Product functions depend on the goods. Please feel free to contact our official distributors if you have any question.

## Warranty Agreement

Warranty periods from the date of delivery : 2 years.

Free repair or replacement services for quality problems are provided within warranty periods.

### **Warranty exclusions below:**

- Beyond warranty periods.
  - Any artificial damage caused by high voltage, overload, or improper operations.
  - Products with severe physical damage.
  - Damage caused by natural disasters and force majeure.
  - Warranty labels and barcodes have been damaged.
  - No any contract signed by LTECH.
1. Repair or replacement provided is the only remedy for customers. LTECH is not liable for any incidental or consequential damage unless it is within the law.
  2. LTECH has the right to amend or adjust the terms of this warranty, and release in written form shall prevail.