

Bluetooth LED Driver

Especially for magnetic track & linear lamp

- Bluetooth 5.0 SIG Mesh with high networking capability is reliable and stable.
- Support direct control on iOS or Android devices through Bluetooth connection.
- Support online upgrade. With ultra-low power consumption, it can be continuously powered on and off to reset it to factory defaults.
- Setting the soft start time and lighting status is supported.
- Work with Super Panel to achieve voice control, cloud scenes and automation.
- No input polarity.
- Multiple output current settings.
- DC to DC constant current output.
- Suitable for STUCCHI standard housings.
- Magnetic installation is quiet without high-frequency sound.
- Smooth dimming curves without flicker.
- Short circuit, overload, no-load and anti-reverse protection.
- 5 year warranty.

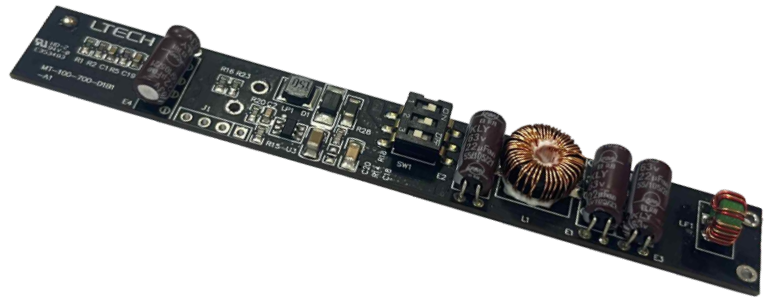

Flicker-free
IEEE 1789



RoHS

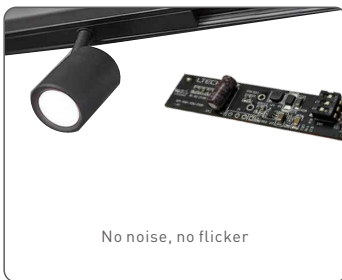

Technical Specs

MODEL		MT-100-400-D1B1	MT-350-700-D1B1
OUTPUT	Output Voltage	9~42Vdc	
	Output Current	100-400mA	350-700mA
	Output Power	1W-16.8W	
	Current Accuracy	+15mA/-25mA	±5%
	Dimming Range	0~100%, down to 1%	
	Channel	1	
INPUT	Dimming Interface	Bluetooth 5.0 SIG Mesh	
	Input Voltage	48Vdc±5% (No polarity)	
	Input Current	0.38A	0.65A
	Efficiency (Typ)	94%	
	Standby Power	<0.5W	
ENVIRONMENT	Working Temperature	ta: -20~55°C tc: 87°C	
	Storage Temperature	-40~80°C	
	Working Humidity	20~95%RH, non-condensing	
PROTECTION	Overload Protection	The load voltage is out of range and the current drops until the power is turned on again.	
	Short Circuit Protection	Close output and automatically recover once the fault is removed.	
	Input Anti -reverse Protection	No input polarity , able to output normally.	

Output Current Selection

* Please select the current through DIP switches on the circuit board when the power is off.



DIP Switch		↑ ↓ ↓	↓ ↑ ↓	↑ ↑ ↓	↓ ↓ ↑	↑ ↓ ↑	↓ ↑ ↑	↑ ↑ ↑	↑ ↓ ON OFF
MT-100-400-D1B1	Output Current	100mA	150mA	200mA	250mA	300mA	350mA	400mA	
	Output Voltage	10-42V	10-42V	10-42V	10-42V	10-42V	10-42V	10-42V	
	Output Power	1-4.2W	1.5-6.3W	2-8.4W	2.5-10.5W	3-12.6W	3.5-14.7W	4-16.8W	

DIP Switch		↓ ↓ ↓	↑ ↓ ↓	↓ ↑ ↓	↑ ↑ ↓	↓ ↓ ↑	↑ ↓ ↑	↓ ↑ ↑	↑ ↑ ↑	↑ ↓ ON OFF
MT-350-700-D1B1	Output Current	350mA	400mA	450mA	500mA	550mA	600mA	650mA	700mA	
	Output Voltage	10-42V	10-42V	10-42V	10-42V	10-42V	10-42V	10-42V	10-42V	
	Output Power	3.5-14.7W	4-16.8W	4.5-18.9W	5-21W	5.5-23.1W	6-25.2W	6.5-27.3W	7-29.4W	

Dimensions

Unit:mm

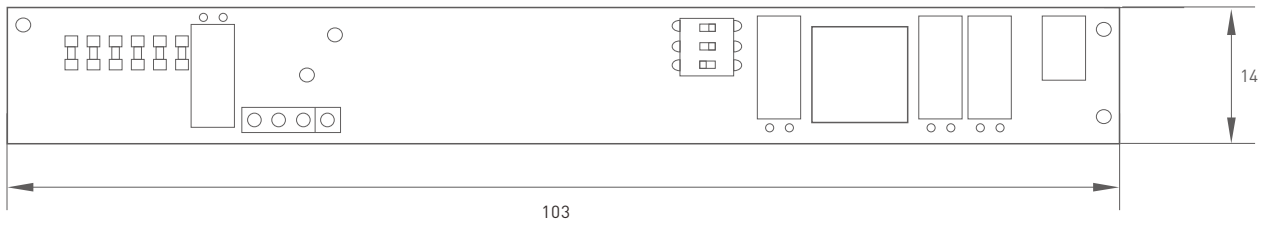
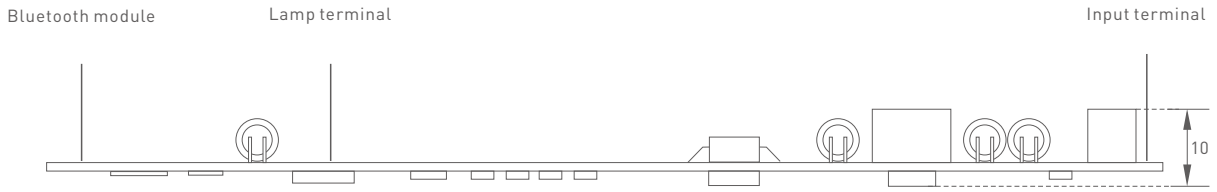

Terminal Description

PCB board

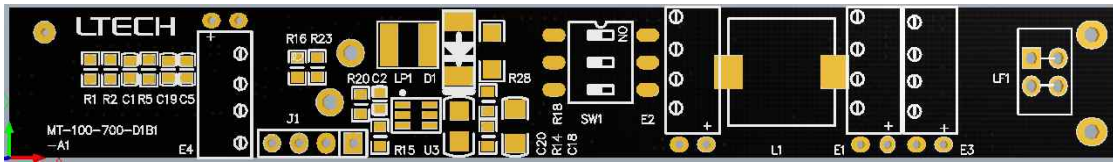

Main view

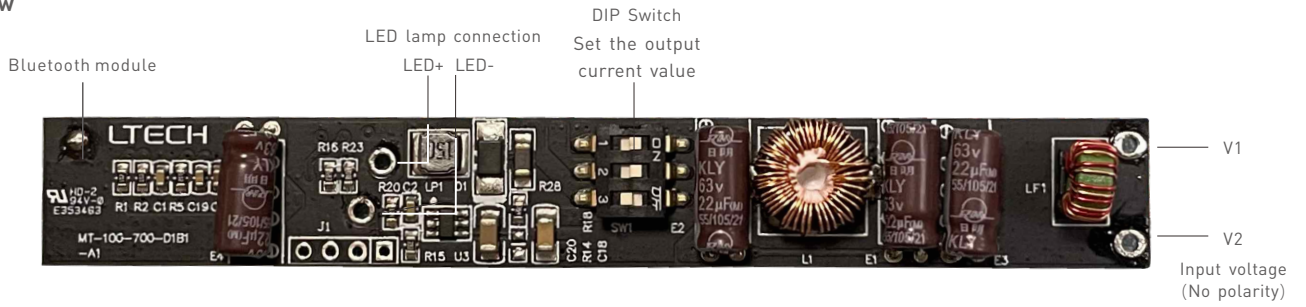

Side view



Wiring Diagram

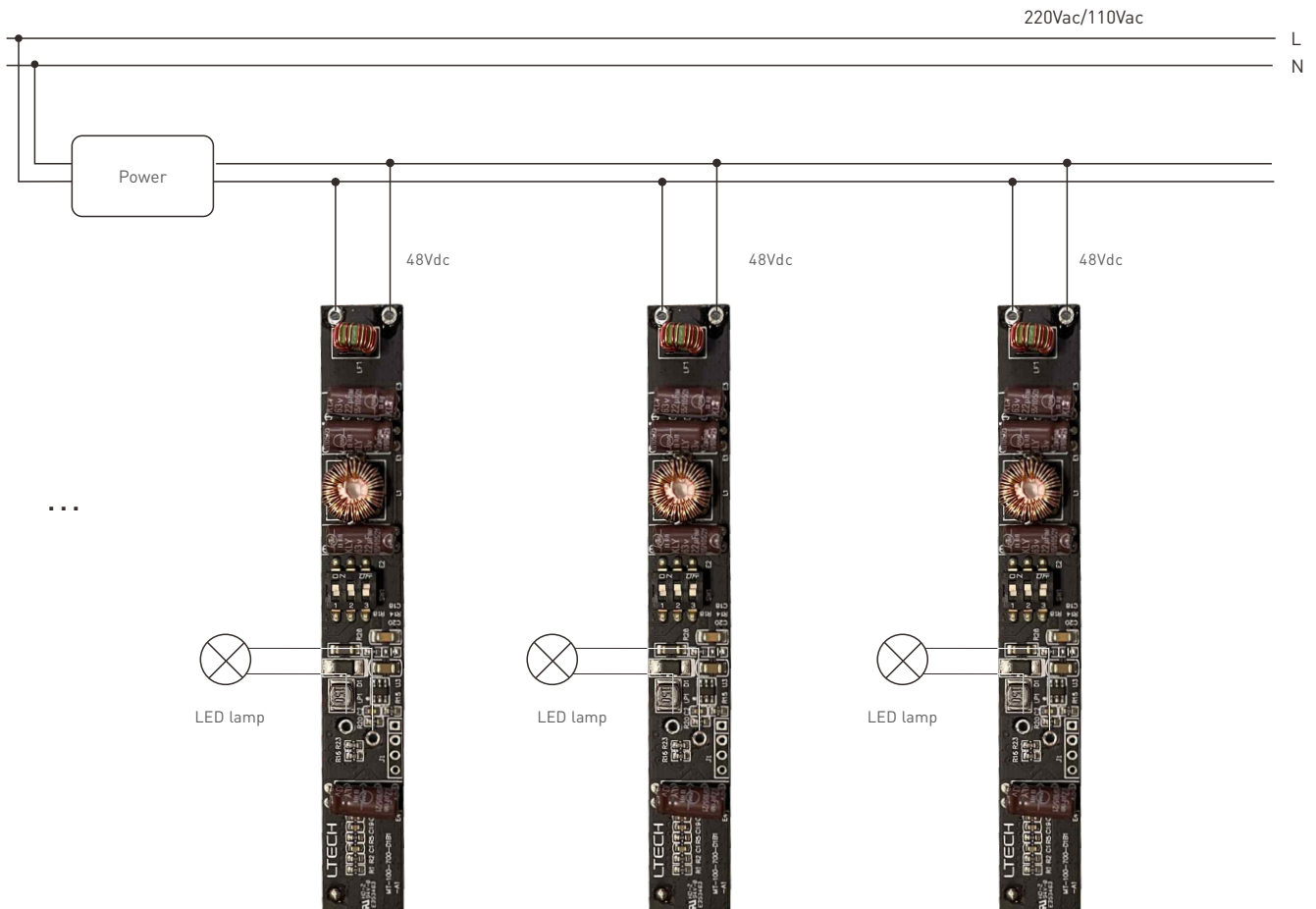

App Operating Instructions

1. Register an account

The App is available on iOS or Android devices. Scan the QR code below with you mobile phone and follow the prompts to complete the App installation. Open the App to log in or register an account.

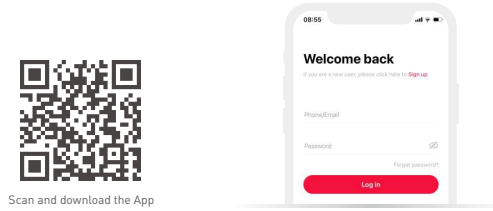

2. Control interface settings

Create a home if you are a new user. Click "+" icon in the upper right corner and access the "Add Device" list. Follow the prompts to add the driver first, then pick "Smart lighting" - "DIM light (BLE)" in the device list. Follow the prompts to power on the device first and make sure the device is not connected to the network, then click "Bluetooth Search" and follow the prompts to add the device.

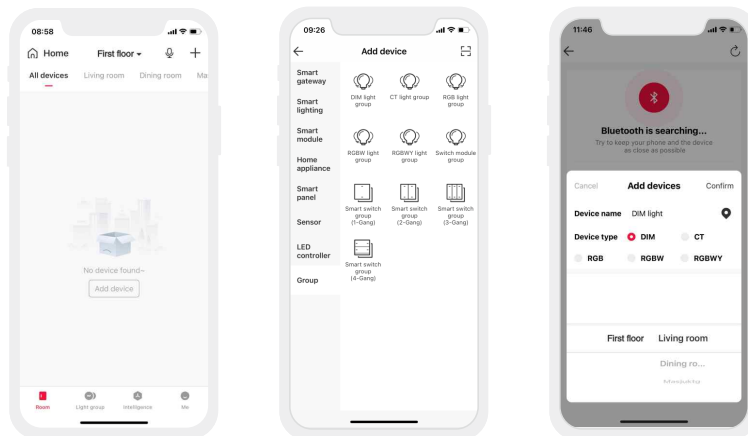

3. Control interface settings

After pairing your device, go to the control interface. You'll be able to achieve your desired lighting effects by changing brightness. Click "Theme" and you'll easily switch to multiple theme lighting effects with one tap. Click "Mode" and the App provides you editable advanced modes. Customize dynamic modes to put you into a more colorful life.

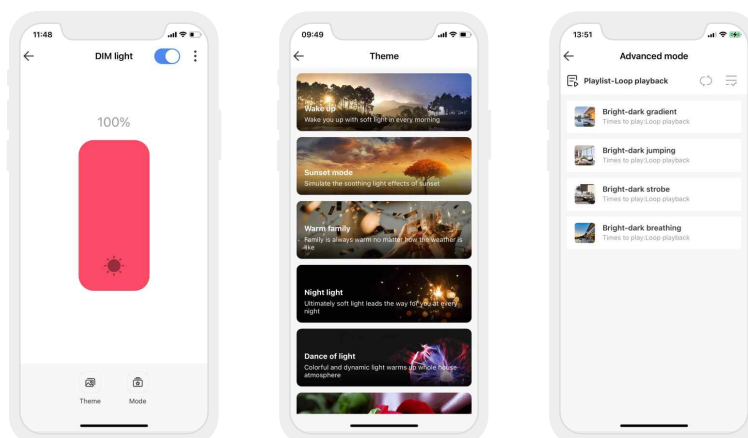

4. Light groups

Users are able to combine the same type of lights into a group. Once you create the group, you can control the entire group of lights more easily. In "Room" interface, click "+" icon in the upper right corner to access "Add Device" list, and select the light group you want, such as "DIM Light Group", then pick the lights you want to group together .

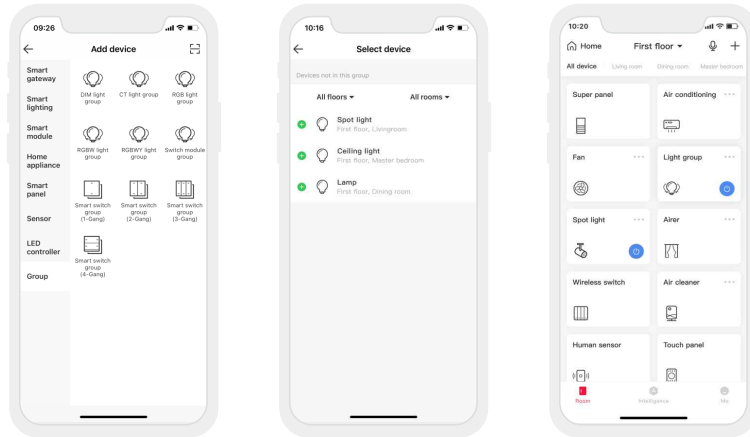

5. Advanced functions

The driver can be linked up with gateway function devices (such as LTECH Super Panel) to achieve the advanced functions such as cloud scenes and automation.

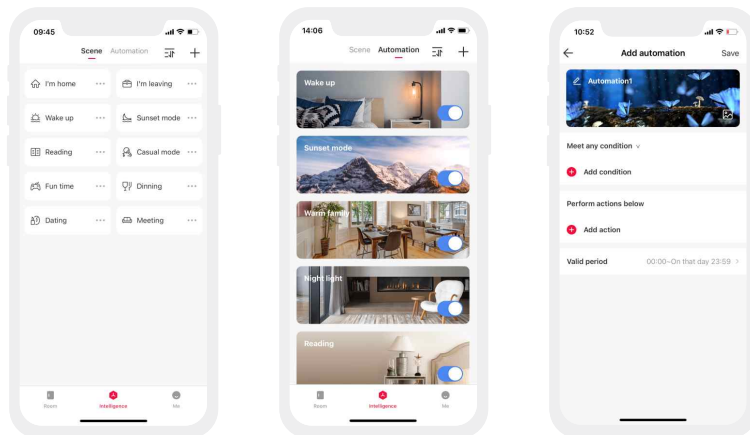

Reset The Device (Reset to factory defaults)

Make sure the driver is well-connected to a lamp and the lamp is on, turn it off with the switch and after 5s turn it on. After 2s, turn it off again. Repeat the same operation 6 times. When the indicator light flashes 5 times, reset the device to factory defaults successfully.

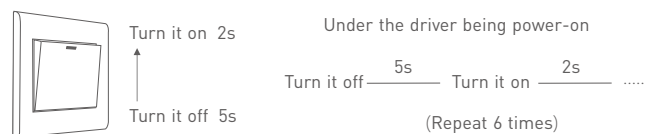

Packaging Specifications

Model	MT-100-400-D1B1、 MT-350-700-D1B1
Carton Dimensions	37×29×19mm (L×W×H)
Quantity	240 PCS/Carton
Weight	0.015 kg/PC; 4.4 kg/Carton

Packaging Image



Carton Packaging

Transportation and Storage

1. Transportation

Products can be shipped via vehicles, boats and planes. During transportation, products should be protected from rain and sun. Please avoid severe shock and vibration during the loading and unloading process.

2. Storage

The storage conditions should comply with the Class I Environment Standards. The products that have been stored for more than six months are recommended to be re-inspected and can be used only after they have been qualified.

FAQs

1. What should I do if I fail to add the device?
 - 1.1 Please make sure the device is powered on normally and is in the activated mode.
 - 1.2 Please make sure the device hasn't been added by any other account. If it did, please reset to factory defaults manually.
 - 1.3 The recommended distance between the mobile phone and the device is no more than 20 meters.
 - 1.4 If the device has been forced to delete, please reset to factory defaults manually and then add the device again.
2. What should I do if the device disconnects from the network?
 - 2.1 Please make sure the device is powered on normally.
 - 2.2 Please make sure the router works normally and the network runs smoothly.
 - 2.3 If you control the device remotely, please make sure your phone network runs smoothly.
3. How to control remotely and set cloud scenes?

Remote control and cloud scenes can be achieved only by working with LTECH Super Panel.
4. How to share control of your home devices?

Please go to "Me" - "Home Management" and access the home you want to share.

Click "Add Member" and follow the prompts to add members to your home.

Attentions

- This product must be installed and adjusted by a qualified professional.
 - This product is non-waterproof (special models excepted). Please avoid the sun and rain. When installed outdoors, please ensure it is mounted in a water proof enclosure.
 - Good heat dissipation will extend the life the product. Please install the product in a environment with good ventilation.
 - Please keep the product away from a intense magnetic field, a high pressure area or a place where lightning is easy to occur.
 - Please check whether the working voltage used complies with the parameter requirements of the product.
 - Before you power on the product, please make sure all the wiring is correct in case of incorrect connection that may cause a short circuit and damage the components, or trigger a accident.
 - If a fault occurs, please do not attempt to fix the product by yourself. If you have any question, please contact the supplier.
- * This manual is subject to changes without further notice. Product functions depend on the goods. Please feel free to contact our official distributors if you have any question.

Warranty Agreement

- Warranty periods from the date of delivery : 5 years.
- Free repair or replacement services for quality problems are provided within warranty periods.

Warranty exclusions below:

- Beyond warranty periods.
- Any artificial damage caused by high voltage, overload, or improper operations.
- Products with severe physical damage.
- Damage caused by natural disasters and force majeure.
- Warranty labels and barcodes have been damaged.
- No any contract signed by LTECH.

1. Repair or replacement provided is the only remedy for customers. LTECH is not liable for any incidental or consequential damage unless it is within the law.
2. LTECH has the right to amend or adjust the terms of this warranty, and release in written form shall prevail.

Update Log

Version	Updated Time	Update Content	Updated by
A0	2020.09.11	Original version.	Xu Shujun
A1	2022.01.21	Added "Output Voltage Range" to P1.	Xu Shujun
A2	2022.06.01	Added "tc: 87 °C" to P1.	Xu Shujun
A3	2022.08.30	Updated the parameter for all products: Updated "Efficiency (Typ)" value as "94%"	Yang Weiling